

Brunswick Street & Smith Street Built Form Review:

JOHNSTON ST BUILT FORM FRAMEWORK

Prepared by **Hansen Partnership**
in conjunction with **GJM Heritage**
for **City of Yarra**
June 2019

FINAL DRAFT

urban planning | urban design | landscape architecture

Contents

Preamble	3
Part 1 : Brunswick & Smith Context	5
Part 2 : Johnston St Precinct Influences	8
Part 3 : A Built Form Proposition	18
Part 4 : Recommended Controls	26

* Note: This Draft document is a part only of a broader Built Form Review for the Brunswick Street and Smith Street Activity Centres : Built Form Review. It is a component part of a broader body of work that sets out a future proposition for two of Yarra's key Activity Centre spines and their adjoining mixed use precincts.



Western section of Johnston Street looking east towards Smith Street

Version	Draft	Final Draft
Issue Date	16.04.2019	28.06.2019

Preamble

The following urban design report has been prepared for the City of Yarra as the basis for an urban design vision for the Johnston Street (west) corridor, located between Nicholson Street and Smith Street. It sets out a preferred built form framework underpinned by an integrated urban design and heritage assessment.

Note: Throughout this report the precinct is referred to as Johnston St, while the street is referred to as Johnston Street.

The report has been prepared by a multidisciplinary team comprising Hansen Partnership (Urban Design) and GJM Heritage (Heritage) with the support of City of Yarra's internal working group.

The study area is identified in Figure 1.

This report sets out the rationale for proposed built form controls for Johnston St and is underpinned by key components, namely:

Part 1: Brunswick & Smith Context

Part 2: Johnston Street Precinct : Influences

Part 3: Johnston Street : Built Form Propositions

Part 4: Recommended Controls

The report is part of a broader Built Form Review.



Oblique aerial of Johnston Street Precinct and surrounding context

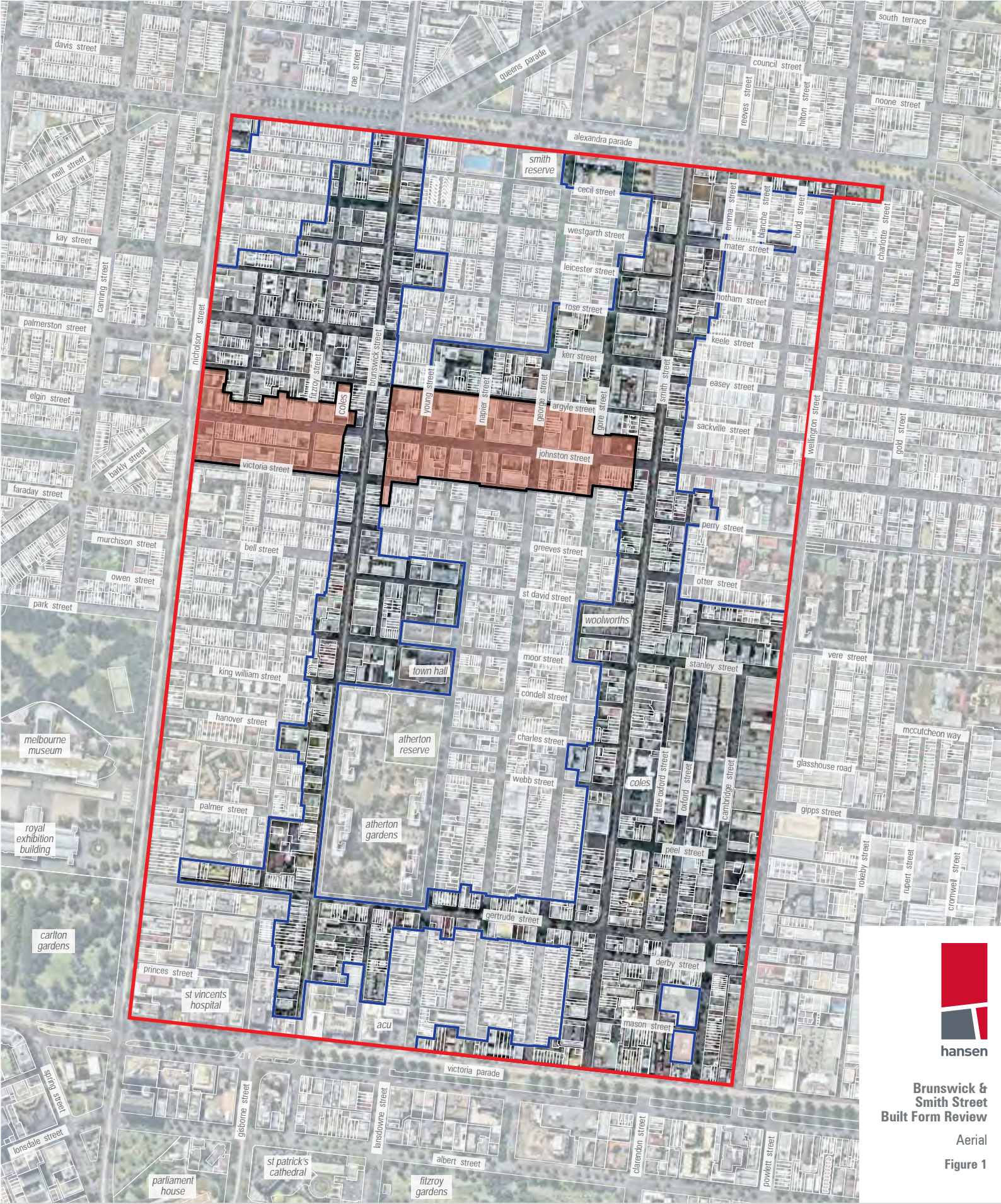

- Legend**
- study area
 - built form review boundary
 - johnston street precinct



hansen

**Brunswick & Smith Street
Built Form Review**

Aerial

Figure 1

Project Ref: 2017.073
 Dwg No.: UDD-002
 Scale: 1:6000 @A3
 Date: 14.06.2019
 Revision: D

hansen partnership pty ltd
 melbourne | vietnam
 level 4 136 exhibition st
 melbourne vic 3000
 t 61 3 9654 8844
 f 61 3 9654 8088
 e info@hansenpartnership.com.au
 w hansenpartnership.com.au

Part 1 :

BRUNSWICK & SMITH CONTEXT

The Brunswick Street and Smith Street Built Form Review seeks to set a clear framework for future change within two of Yarra's key Activity Centres and their adjoining Mixed Use area. Planning policy identifies such Activity Centres as areas for accommodating growth and change. Therefore, these are the areas that must be carefully planned and managed in order to accommodate progressive change while protecting (or indeed enhancing) existing established character and heritage values.

The project was initiated in May 2017 and encompasses large areas bound by Alexandra Parade (to the north), Victoria Parade (to the south), Wellington Street (to the east) and Nicholson Street (to the west).

As part of the process extensive analysis of the existing conditions was undertaken and documented within an overall Background report. This comprehensive analysis identified and divided the overall Review Area into ten 'place specific' precincts. Furthermore, a series of guiding objectives were identified to be contemplated across ten defined precincts.

A Collingwood Precinct report was prepared in June 2018.

The Johnston St and Fitzroy East Precincts were prepared in tandem, given the somewhat merged condition between the mixed use Fitzroy East pocket and commercial zone along the eastern section of Johnston Street.

This report addresses the Johnston St Precinct. The remaining seven other precincts will be addressed in subsequent reports.

1.1 Overarching Built Form Objectives

The following 8 objectives have been identified:

Objectives:

1. Recognise and carefully manage potential in key areas within the Activity Centres.
2. Highlight the character distinctions between the different retail streets and mixed use precincts within the Activity Centres.
3. Reinforce the traditional Victorian cityscape of heritage streetscapes as dominant elements, including significant corner elements and identified local landmarks.
4. Ensure continued diversity through sensitive infill within traditional Victorian streetscapes.
5. Shape the retail streets and mixed use areas to ensure a high quality, people-oriented public realm.
6. Ensure development encourages walking, cycling and public transport usages through layout and design responses.
7. Ensure new development is sustainable and adaptive over time.
8. Manage the built form profile of new development to avoid adverse impact to surrounding areas, including heritage places, streetscapes and residential interfaces.



Southern Johnston Street streetscape between Nicholson and Brunswick Streets

1.2 Brunswick & Smith Built Form Precincts

Based on the initial analysis phase of the project the following Precincts were identified spatially as relatively coherent parts. The Precincts are largely defined by function as either:

- an Activity Spine;
- a Mixed Use Area; or
- a Boulevard.

Activity Spines

The Activity Spines are defined by the 'traditional' retail and commercial functions along the four main streets within the review area of:

- Brunswick Street;
- Smith Street;
- Gertrude Street; and
- Johnston Street.

Mixed Use Areas

The Mixed Use Areas are defined by the mixed use functions present in the non-residential land located generally in local streets, behind the Spines. The four renewal areas within the review area are:

- Fitzroy West;
- Fitzroy East;
- Collingwood; and
- Town Hall.

Boulevards

The Boulevards are the non-residential land to the northern and southern edges of the review area which front the broad road corridors of:

- Alexandra Parade; and
- Victoria Parade.

10 Precincts

The 10 precincts within the Brunswick & Smith Street Built Form Review are:

- Precinct 1: Brunswick Street (B);
- Precinct 2: Smith Street (S);
- Precinct 3: Gertrude Street (G);
- Precinct 4: Johnston Street (J);
- Precinct 5: Fitzroy West (FW);
- Precinct 6: Fitzroy East (FE);
- Precinct 7: Collingwood (C);
- Precinct 8: Town Hall (TH);
- Precinct 9: Alexandra Parade (A); and
- Precinct 10: Victoria Parade (V).

This report addresses Precinct 4: Johnston Street.

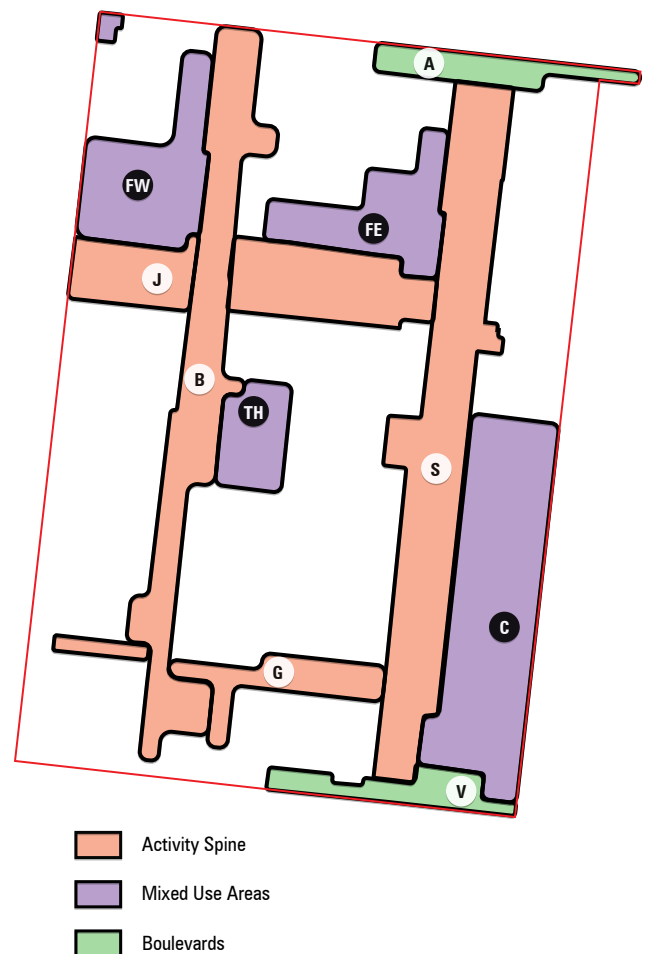

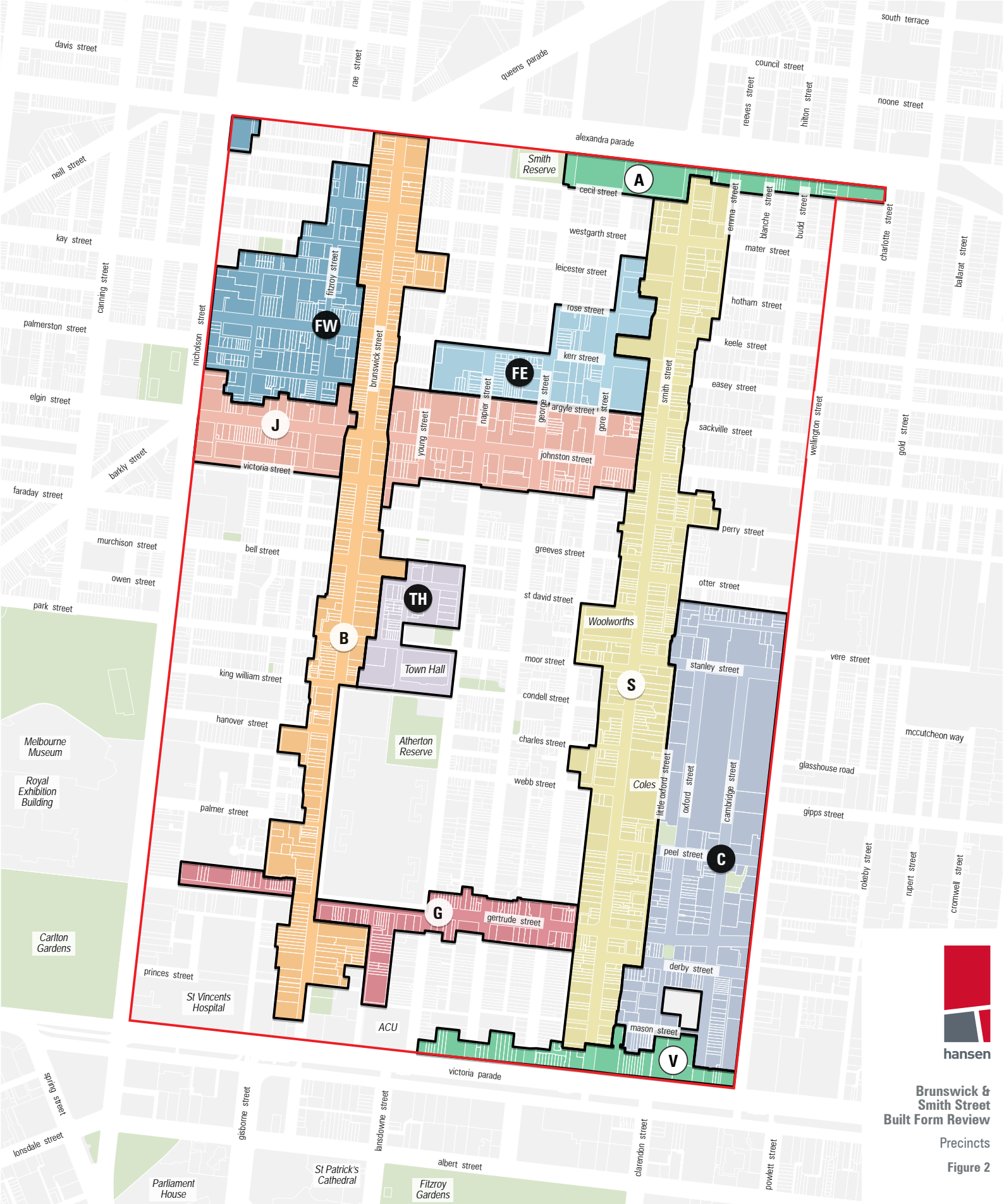

**Brunswick & Smith Street
Built Form Review**
Precincts
Figure 2

Legend	Activity Spines	Mixed Use Precincts	Boulevard Precincts
study area	brunswick street	fitzroy west	alexandra parade
precinct boundary	smith street	fitzroy east	victoria parade
	gertrude street	collingwood	
	johnston street	town hall	

Project Ref: 2017.073
 Dwg No.: UDD-025
 Scale: 1:6000 @A3
 Date: 04.06.2019
 Revision: F

hansen partnership pty ltd
 melbourne | vietnam
 level 4 136 exhibition st
 melbourne vic 3000
 t 61 3 9654 8844
 f 61 3 9654 8088
 e info@hansenpartnership.com.au
 w hansenpartnership.com.au

Part 2 :

JOHNSTON ST INFLUENCES

Johnston St today is a mixed urban area, main street corridor defined by the coexistence of heritage shopfront forms, new apartment developments and remnant Victorian era cottages and corner pub buildings. These prevailing elements sit side by side with more modest 20th Century forms that is 'ripe' for renewal.

The extent of the Johnston St Precinct is set out in Figure 3 and includes sections of the following streets:

- Johnston Street;
- Victoria Street;
- Spring Street;
- Fitzroy Street;
- Young Street;
- Napier Street;
- George Street;
- Elliot Street;
- Chapel Street; and
- Gore Street.

Boundary Description

This precinct encompasses all Commercial 1 Zoned land which fronts both sides of Johnston Street, as well as the Mixed Use properties along the northern side of Victoria Street. The western extent is defined by Nicholson Street and the eastern extent is defined by the rear of properties which front the western side of Smith Street. The southern extent is defined by the non-commercial zones and the northern extent is defined by the edge of the Commercial 1 Zone.

Built Form Character

The Johnston Street precinct, between Smith and Nicholson Streets is a critical opportunity spine in Fitzroy and part of the long corridor linking Johnson Street East (in Collingwood) with Elgin Street (within the City of Melbourne) to the west. This particular section of Johnson Street is mixed in profile with two very distinctive portions. Firstly, an eastern area (between Smith and Brunswick Streets) which comprises some deep former industrial lots and a mixed arrangement of retail, residential and contemporary infill. Secondly, a smaller western area (between Brunswick and Nicholson Streets) comprising typically fine-grained traditional retail stock and some important heritage elements, most notably at the Nicholson Street junction and extending southward along Victoria Street. Both precincts are 'hemmed in' by sometimes delicate residential stock principally to the south and more mixed fabric to its north. Johnston Street crosses (on a perpendicular alignment) the key Smith Street and Brunswick Street activity spines and offers long terminal views is to the west to the municipal threshold and uphill towards the University of Melbourne.

For a more detailed description of existing conditions refer to [section X](#) of the Background report.



Diverse southern side of Johnston Street, between Hertford and Young Streets



hansen

Brunswick & Smith Street Built Form Review

Johnston Street Precinct Boundary

Figure 3

Legend

Johnston Street Precinct boundary 



2.1 : Foundation

Setting an agreed vision for this section of Johnston Street and Fitzroy East must be underpinned by a critical understanding of its diverse conditions, including the fabric of existing and approved buildings and relevant 'foundation' influences as set out in Figure 4 and as follows:

Topography & Views

The precinct has relatively limited topographic features, the most notable characteristic being a slight incline on the Smith Street approach from the west, before gradually falling toward the Yarra River to the east. This subtle rise offers long range views along the Johnston Street spine towards Parkville in the west, punctuated by the Redmond Barry building at the University of Melbourne, and terminated by dense vegetation straddling the Yarra River, with the Dandenong Ranges visible in the background to the east.

Grid Street Network

The precinct is defined by the east-west orientation of Johnston Street anchoring a varied grid pattern with a clear street hierarchy, with Johnston Street as the main street defined by its arterial road function and associated activity. The 20m wide movement corridor of Johnston Street is of the same width as the distinct north-south oriented green streets of Napier, George and Gore Streets and the east-west oriented Kerr Street. While secondary streets of 10m in width include Young Street, Spring Street, Fitzroy Street and Argyle Street. Urban blocks on the northern side of Johnston Street are more consistent in order when compared to those on the southern side, particularly east of Brunswick Street, comprising a mix of fine grain and broad frontage lots. A number of laneways provide rear access to commercial and residential allotments, some of which terminate mid-block and others continue through to parallel and adjacent streets.

Key Junctions

The precinct comprises several prominent junctions along the Johnston Street spine which act as important gateway elements and create a clear division in built form character and rhythm. Key junctions include Nicholson Street to the west of the precinct, with the eastern side of the junction located in the City of Melbourne as well as Brunswick Street and Smith Street, both critical transport and pedestrian movement nodes. Other notable junctions are positioned to the north of Johnston Street, along the grid network with defining corner buildings and breaks in canopy vegetation.

Subdivision Pattern

The street, block and lot pattern across the Review Area is varied and diverse. Varying from a section of consistent, fine grain lots along the southern side of Johnston Street, towards Nicholson Street that are serviced by a rear laneway, to areas of highly varied and irregular lots to the east of Brunswick Street. While, on the northern side of Johnston Street the subdivision is generally comprising of larger and broader lots, except for the scattered provision of fine grain residential parcels.



Distant view along Johnston Street to the Dandenong Ranges



View along Johnston Street towards Redmond Barry building



Tankerville Hotel at corner of Nicholson Street and Johnston Street



Fitzroy Post Office at corner of Brunswick Street and Johnston Street

Movement Corridors

Napier Street is a significant cycle corridor through Fitzroy extending from Gertrude Street in the south and terminating at Fitzroy Swimming Pool in the north at Alexandra Parade. This is an important link in the context of metropolitan Melbourne as it provides efficient and safe cycle access parallel to the busy tram and vehicle corridors of Nicholson, Smith and Brunswick Streets, connecting with dedicated cycle paths outside of the municipality.

Adjoining Built Form Precincts

The proximity of the Smith and Brunswick Street Activity Centre spines is notable within the context of built form character and legibility throughout the precinct. The Smith Street spine is located to the eastern interface of the precinct (on higher ground) and the Brunswick Street spine divides Johnston Street into two distinct components, comprising varied grain and heritage values. Both streets provide a vibrant main street condition comprising significant heritage assets at intersecting junctions.

Johnston Street Activity Spine

The Johnston Street Activity Spine is an important corridor in the context of the Major Activity Centre. Traversing through Brunswick and Smith Streets, the corridor comprises a mix of fine grain retail premises, large format commercial premises and late night venues inviting a mix of pedestrian activity along its extent. There are a number of distinctions and 'shifts' in the Johnston Street corridor, with a different streetscape character evident to either side of Brunswick Street. While relatively void of street trees or weather protection, the streetscape is still a popular pedestrian link between key destinations throughout Fitzroy and Collingwood. It also accommodates numerous bus routes, reinforcing its through traffic movement within the broader main road network.

Green Streets

The linear north-south streets of Napier, George and Gore Streets as well as the east-west aligned Kerr Street comprise significant mature canopy vegetation (typically deciduous Plane Trees) within the road reserve, enclosing the streetscape. These streets are a stark contrast to other streets within the precinct, which typically have limited street trees and vegetation.

Heritage

Most of the precinct is subject to the Heritage Overlay (H0334), comprising individually significant and contributory buildings of varying typologies including fine grain shops, dwellings, warehouses and pubs. Several buildings of individual significance are subject to a site-specific Heritage Overlay including the Former Avon Butter Factory (H0471), and Holyrood Terraces (H0168-170). While the HO extends across most of the Precinct, notably there are numerous clusters of lots, particularly between Brunswick and Smith Streets to the north of Johnston Street, which comprise non-contributory buildings.



Nicolson Street tram corridor



Brunswick Street spine, looking south across Johnston Street



Gore Street looking south towards Rose Street



Former Avon Butter Factory at corner of Nicholson Street and Victoria Street

Traditional Fine Grain

Rows of continuous cottages and retail buildings of heritage significance are a defining characteristic throughout the precinct. This includes along the Johnston Street spine (particularly to the south) as well as the residential blocks to the north of Argyle Street. These forms create a distinctive character and present stark transitions to neighbouring sites.

Prominent Corners

There are several corner sites along the Johnston Street spine (to the south) comprising prominent heritage forms (of individual significance). These two storey forms present ornate parapet treatments which mark their prominent corner positions and are identified as local landmarks. This includes Tankerville Hotel on Nicholson Street, Fitzroy Hotel on Napier Street and Rochester Hotel on George Street. Other prominent corners include the Marquis of Lorne Hotel on George and Kerr Streets as well as significant heritage forms on all 4 Brunswick and Johnston Street corners.

Recent Development Trends

Substantial medium to high density development has occurred throughout the precinct, particularly on consolidated sites with limited heritage constraints. Development ranges in scale from 4 to 6 storeys in side streets up to 10 storeys along the Johnston Street spine (under construction). Recent planning permit approvals in the precinct are typically 6-8 storeys in height.

Open Space

There is a lack of notable public open space in the precinct. The Fitzroy Primary School provides a reprieve in built form with generous open space for students, but is located just outside the precinct. The nearest public open spaces are generally found across Nicholson Street spread across Carlton. Council have ambitions for a new public open space provision within the precinct.



Row cottages along south side of Johnston Street, near Rochester Street



Rochester Hotel at corner Johnston Street and George Street



Recent development at corner of George Street and Argyle Street



Fitzroy Primary School grounds



hansen
 Brunswick & Smith Street Built Form Review
 Johnston Street & Fitzroy East Foundation Information
 Figure 4

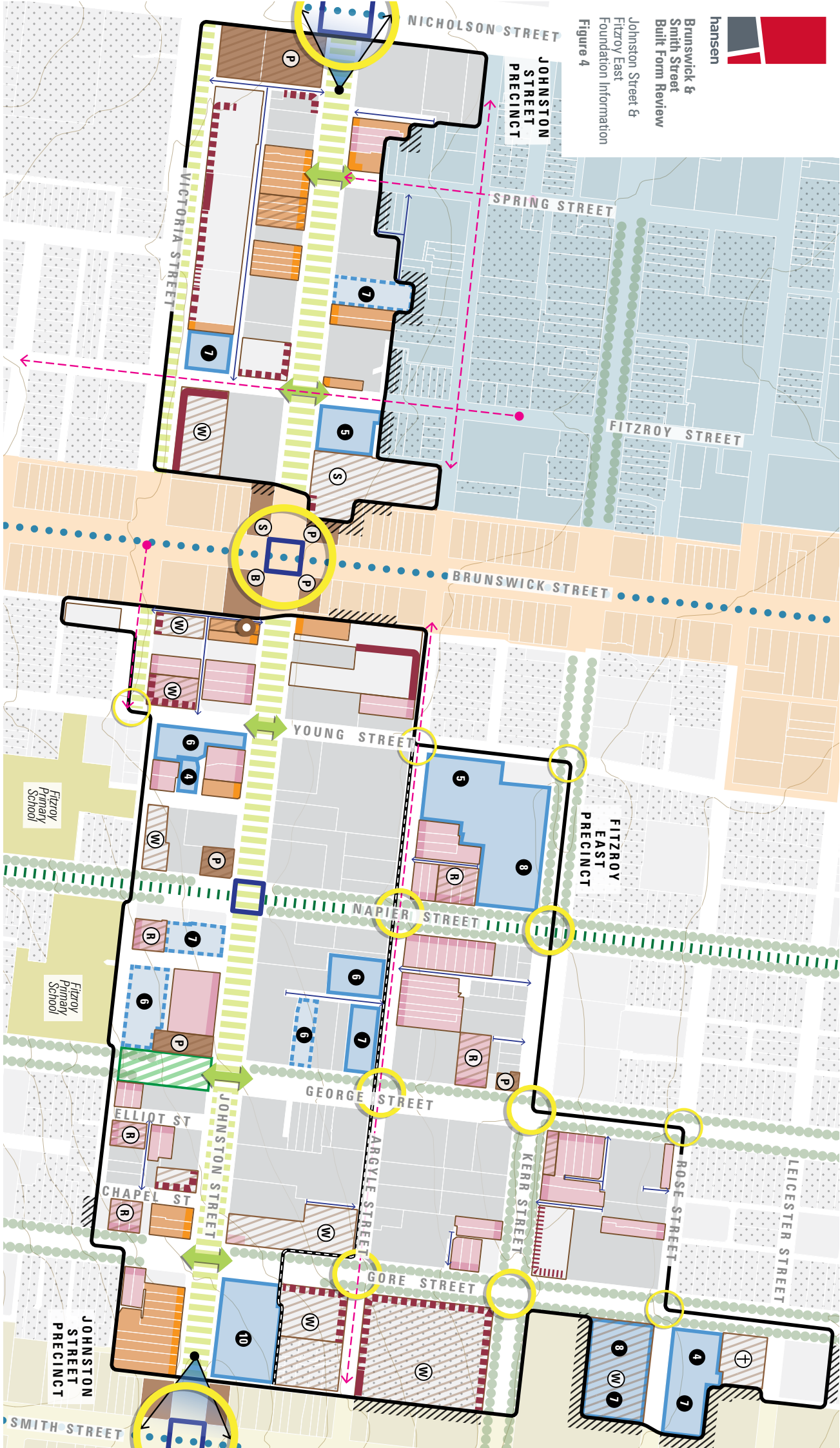

- Legend**
- Johnston and Fitzroy East Precinct boundary
 - Brunswick Street Precinct
 - Smith Street Precinct
 - Fitzroy West Precinct
 - School

- Existing Built Form**
- Constructed redevelopment
 - Approved development
 - Approved/constructed heights
 - Individual heritage significance
 - Contributory heritage building
 - Fine grain residential
 - Fine grain commercial
- Heritage corner form**
- Warehouse streetwall: Low
 - Warehouse streetwall: Medium
 - Warehouse streetwall: High
 - Local landmark
 - Pub building
 - Church building
- Residential building**
- Warehouse building
 - Bank building
 - Shop building
 - Opportunity parcel
 - Established residential area
 - Direct precinct boundary interface

- Movement**
- Tram
 - Signalised junction
 - Existing lane
 - Pedestrian focus
 - Pedestrian desire line
 - Cycle way
 - Main junction
 - Grid junction
 - Local junction

- Public Realm**
- Green streets
 - Potential public open space opportunity
 - Key views
 - Glimpse views

Project Ref: 2017_073
 Dwg No.: UDD-027
 Scale: 1:2000@A3
 Date: 14.06.2019
 Revision: C

2.2 : A Johnston St Change Framework

In response to these foundation matters, an Urban Design Framework has been advanced to reinforce indicative locations for varying level of change within the locality. A Framework is not definitive (like a Built Form Control Plan). It seeks to identify ‘gestures’ that shape the look and feel of the city. In this instance, the framework recognises the importance of the following:

Corridor Effects

While this precinct represents a least two distinctive parts, a framework envisages a sense of continuity and a corridor effect defining the urban form relationship between Smith and Nicholson Streets assisting and consolidating the connection of the Activity Centre. This area, comprising two large urban precincts and eight to ten urban blocks is clearly distinctive from the undulating topography of Johnston Street in Collingwood leading with slope down to Hoddle Street and beyond. It is also distinctive from land beyond the City of Yarra to the west leading uphill and Elgin Street. A corridor effect does not require ‘consistency’, indeed considerable variety is intended on either side of Johnston Street to the east as distinct from more uniform response in the west.

Heritage values

The precinct contains a number of notable ‘runs’ of attached intact retail (and also residential) streetscapes. These are most apparent on the south side of Johnston Street to the east, but also occupy both sides of Johnston Street to the west. These important factors shape future form with respect to streetscape presentation and overall capacity for change. Johnston Street East (south side) is unique in that it presents at least eight intersections/junctions which makes the realization of a consistent form difficult. The south side of Johnston Street East can therefore be variable in between the individual heritage contributors. Johnston Street West is quite different, it comprises particularly long urban blocks and only one cross intersection. In this context of continuous streetscape form to both sides allows for connectivity between heritage street walls, with the necessary punctuation at the important heritage corner elements on Nicholson Street.

Growth Opportunities

A rare precinct on Johnson Street (north) between Young and Gore Streets (generally bound to the north by Argyle Street) has the opportunity for more substantial change as indicated by a suite of current approvals and the occurrence of remnant industrial parcels across entire urban blocks. While this area is currently affected by a Heritage Overlay, few legitimate heritage values exist. However, this particular locality does not have potential for unbridled growth – given the urban blocks and the important streetscapes as well as the principal Johnston Street spine. They also represent locations that must embody transitions to the more sensitive northern neighbours.



Johnston Street corridor, looking east



Johnston Street corridor, looking west



Non-heritage forms on the north side of Johnston Street (West)



Continuous heritage fabric along the southern side of Johnston Street (East)

Corners

The definition of street junctions and local corners assists in the legibility of the area. In Johnston Street, the passage past Smith, Brunswick and Nicholson Streets is each 'marked' with notable retail, bank or hotel buildings that assist in placemaking. Corners are particularly important on the south side of Johnston Street East as they hold locations for notable heritage hotel buildings and other corner features which define the local skyline. The passage of major north-south green streets (Napier, George and Gore Streets) also provide the opportunity for pedestrian crossing and identity links in these locations. Corners are less important in the western precinct, except at the Nicholson Street junction which serves as a key demarcate of the municipal edge and the major Nicholson Street threshold.

Street width to building height relationships

The relationship between building heights (and street presentation) to street width is a strong defining element of the character and 'sense of place'. In mixed use or commercial spines such as Johnston Street, a more prominent character is expected to encourage a proportional relationship between buildings and streets. This is to create a balance between openness and enclosure from within the public realm. In order to maintain a comfortable street environment and an appropriate 'sense of enclosure', a 1:1 relationship between the overall building height and width of the street is recommended as the basis for defining building heights. Importantly, the east-west alignment of the streetscape means that street wall treatments and overall heights above should not overshadow south side footpath to ensure a high amenity public realm.

Secondary Streetscapes

Unlike other commercial spines, a number of urban blocks within this precinct have secondary addresses to streetscapes located parallel to the Johnston Street spine. Including Chapel and Victoria Streets to the south and Argyle Street to the north. While some allotments that front Johnston Street extend the full depth to a secondary street, others are subdivided with a principal address to the secondary street. It is imperative that there is distinction between an urban form that front Johnston Street and the principal retail- mixed use spine, and the form that addresses the secondary streets. The nature of this condition will change subject to existing form – for example, the former industrial format in Victoria Street is distinctive to the green civic qualities south of Chapel Street (including the Primary School grounds).

Approved-constructed developments

This precinct has already been subject to a considerable degree of development and change, including a suite of approved and now constructed development of between 4 to 10 storeys in scale. A number of these elements are not new, however some are approved but not yet realised. These development envelopes (while often approved by VCAT) are relevant factors in contemplating the opportunity for continued infill along the Johnston Street spine. Almost all approved developments along Johnston Street employ a traditional street wall, with setbacks to rising form above. This model is appropriate as a continued response along the corridor.



Tankerville Hotel, defines the corner of Johnston and Nicholson Streets



Argyle Street built form profile



Former industrial forms along the northern side of Victoria Street



VCAT approved development along south side of Johnston Street (West)



FORM FRAMEWORK REPORT

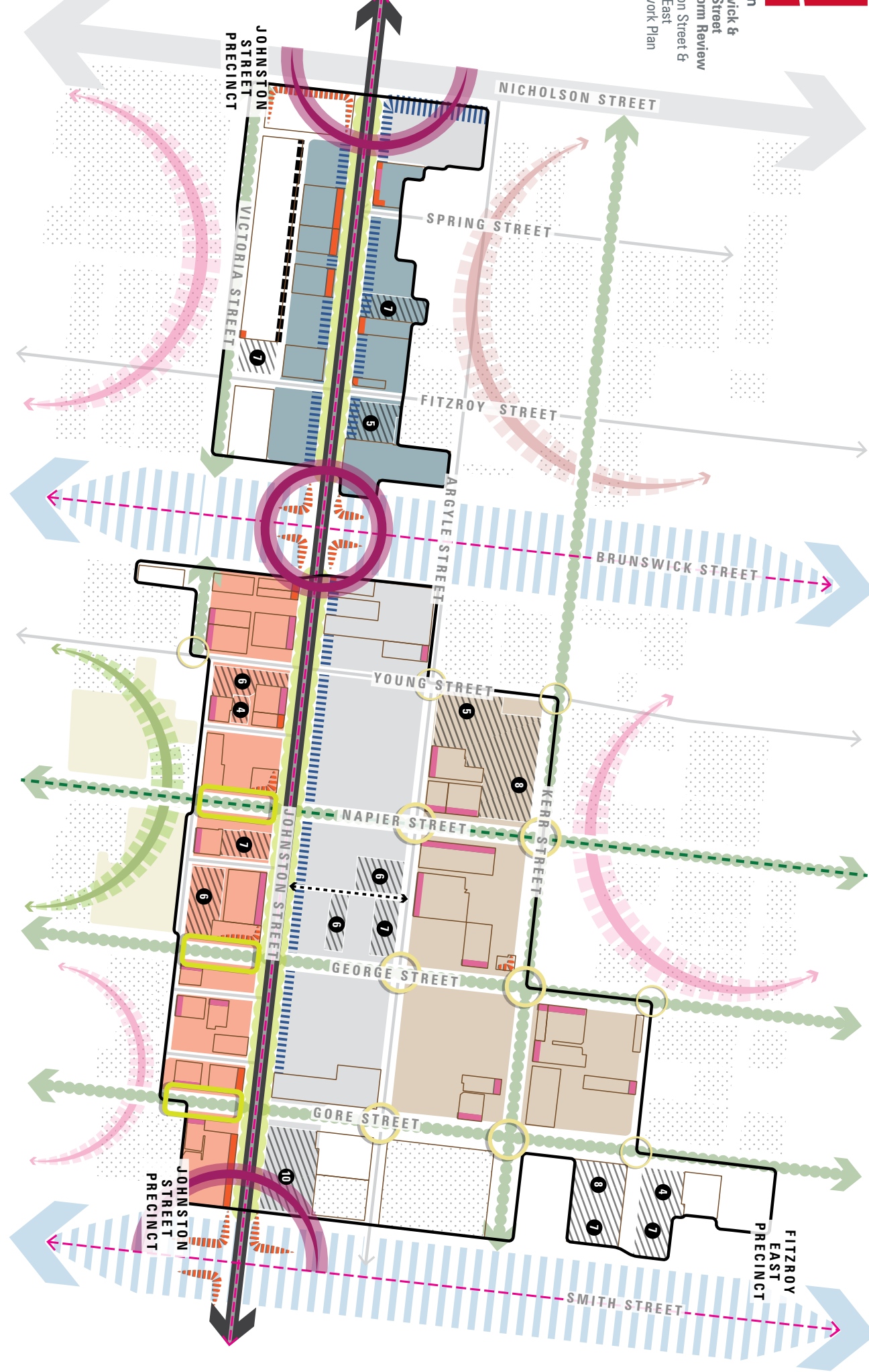

- Legend**
- Johnston and Fitzroy East Precinct boundary
 - Opportunity
 - Order
 - Diversity
 - NRZ Transition
 - Commercial spine
 - Key movement corridor
 - Heritage form
 - Development
 - Development height
 - Street definition
 - Transition to laneway
 - Prominent corner form
 - Laneway opportunity
 - Key views outside precinct
 - Green streets
 - Public open space opportunity
 - Cycle corridor
 - Key junction
 - Grid junction
 - Local junction
 - Street greening opportunity
 - Established residential
 - School
 - Green civic fringe
 - NRZ interface
 - Residential mixed use interface
 - Fine grain commercial
 - Fine grain residential

Given this 'Framework' for change, the following future character statement is recommended.

Future Character Statement

Johnston Street, between Smith and Nicholson Streets is a decidedly mixed corridor comprising a suite of different development opportunities, grounded in the traditional urban block subdivision format of land. The north side of Johnston Street, between Smith and Brunswick Streets has the greatest capacity for change, with future form occupying almost entire urban blocks that are not affected by heritage values or remnant buildings of any notable quality. This provides an opportunity for a new mixed-use model that is compliant to the Johnston Street frontage, but also inviting the through block connectivity and side street address. The south side of Johnston Street, between Smith and Brunswick Streets is decidedly mixed with at least eight intersecting perpendicular streets providing a combination of traditional hotel corner buildings, attached retail and residential stock and opportunities for subtle infill in transition to the residential and civic land to the south. Johnston Street between Brunswick and Nicholson Streets and the municipal threshold demands a more consistent approach, the street wall connectivity linking existing remnant heritage forms on both sides of the street. This strip must carefully integrate with mixed commercial and institutional forms located to the north and south, Argyle and Victoria Streets respectively, with a key point of demarcation that Nicholson Street, with a heritage values on the south side may be offset by future form of note on the northern junction. The corridor is unified, not by any consistent built form response (indeed it is defined by is clearly by variance), but by consistent of visual profile and pedestrian realm that links the Smith Street ridgeline with the Nicholson Street junction.

The western precinct will continue to present an orderly and more consistent streetscapes defined by retained heritage fabric that should remain the dominant future character element. The Victoria Street former industrial forms can support complementary 'pop-up' forms, while upper levels to Johnston Street to be setback to maintain the visual prominent of the streetwall.

The eastern precinct is more diverse and can support stronger form along the northern side of Johnston Street, while the southern side will remain mixed and more modest in scale.

In response to this distinction in urban fabric of the precinct the future built form character will seek to build on this diversity.

This includes:

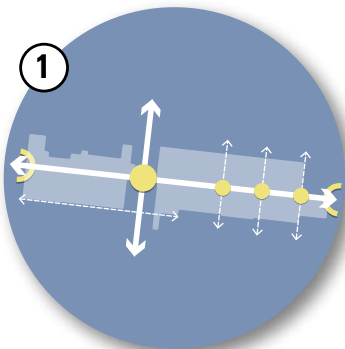

1 Strengthen key junctions and urban corridors.

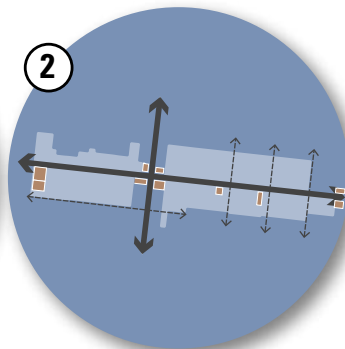

2 Protect prominent heritage corner forms.

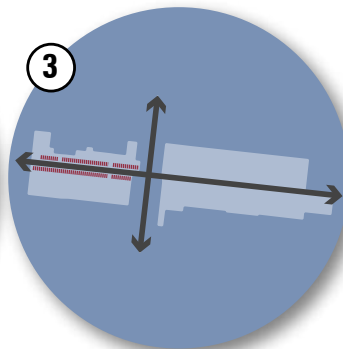

3 Reinforce the consistent fine grain presentation along Johnston Street (West).

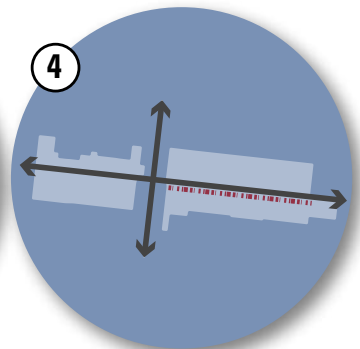

4 Foster diversity along the southern side of Johnston Street (East).

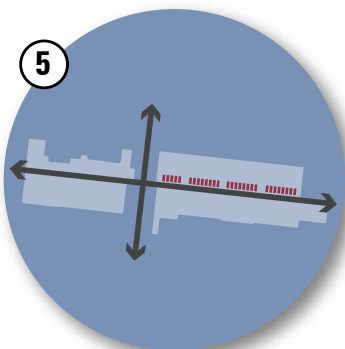

5 Encourage strong street definition along the northern side of Johnston Street (East).

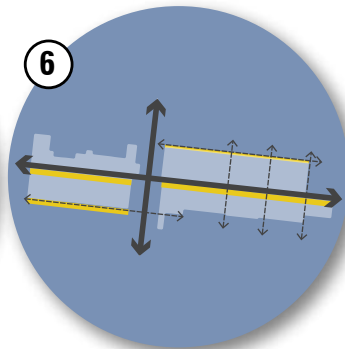

6 Maintain solar access to the southern footpath along Johnston Street.

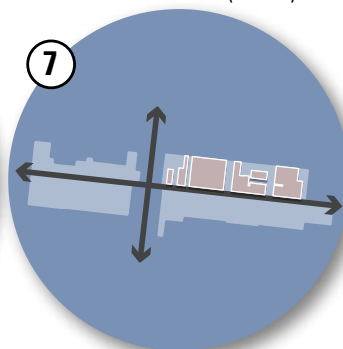

7 Realise development opportunity on large non-heritage sites.

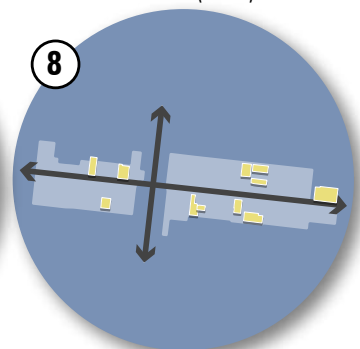

8 Acknowledge existing and approved development.

Part 3 :

A BUILT FORM PROPOSITION

The Built Form Proposition has been derived from the Framework, which was informed by the Foundation and underpinned by the overall Background analysis.

The Johnston St Built Form Proposition sets street by street parameters for the precinct's evolution. The parameters identified are neither fixed or absolute, but intended as benchmarks to guide change. They are represented in Figure 6 and are derived from the following basis.

- Heritage Input;
- Street Character;
- Street Proportions;
- Solar Access;
- Transitions;
- Slope;
- Local Views and Vistas
- Heritage Streetwall & Upper Levels;
- New Streetwalls & Upper Levels;
- Upper Level setbacks;
- Upper Level Expression;
- Main Street Corners;
- Street Corners;
- Building Separation, Amenity & Equitable Development;
- Residential Interfaces;
- Public Open Space Interface; and
- Service Laneway Interfaces.



Johnston Street streetscape, looking east from George Street towards Smith Street

3.1 Basis of Height Parameters

Heritage Input

GJM Heritage undertook extensive heritage analysis which considered:

- The suitability and extent of the Heritage Overlays;
- The heritage grading of each property within the Heritage Overlay;
- The currency of the existing Statements of Significance;
- Places which may warrant nomination to the Victorian Heritage Register; and
- Recommended built form parameters to appropriately manage development within the heritage context.

Refer to GJM Heritage report for details.

Street Character

The existing streetscape character of Johnston Street is classified into two distinct sections and associated built form character, with a consistent and fine grain character to the west of Brunswick Street consisting of predominantly fine grain and continuous 2 storey streetwall. While, to the east of Brunswick Street, on larger and broader allotments Johnston Street comprises a more varied and diverse built form.

A key characteristic of the Johnston St Precinct is its continuous streetwall. New buildings should seek to sensitively respond to the surrounding streetscape context.

Street Proportions

Default preferred maximum building heights have been derived in relation to the adjoining street width. This has been based on considerable analysis and documentation of the existing relationships throughout the broader study area, which has shown there to be a strong correlation between the width, function and character of the street to the height and profile of the buildings which line it. Based on analysis, a 1:1 ratio (between street width and building height) suitably balances a street edge definition and outdoor amenity. Therefore, as a starting point, the preferred overall building height of new forms can be determined by the width of the street. The size and depth of allotments and lack of sensitive interfaces was another factor when considering an increase in the default ratio as small and shallow lots would not be able to accommodate taller forms. We suggest the following:

- Up to 1:1 – Default street width to overall building height ratio
- Up to 1:1.5 – Increased street width to overall building height ratio (main street corridors with moderate size lots)
- Up to 1:2 – Maximised street width to overall building height ratio (main street corridors at key junction locations, terminal vistas with moderate to large size lots)

Therefore, the preferred maximum heights have a strong correlation between the street widths and the street’s function and character. However, in order to respond to the prevailing streetwall scale, set backs to upper levels are required. They are also determined by the size and depth of lots, noting need for rear boundary transition conditions.

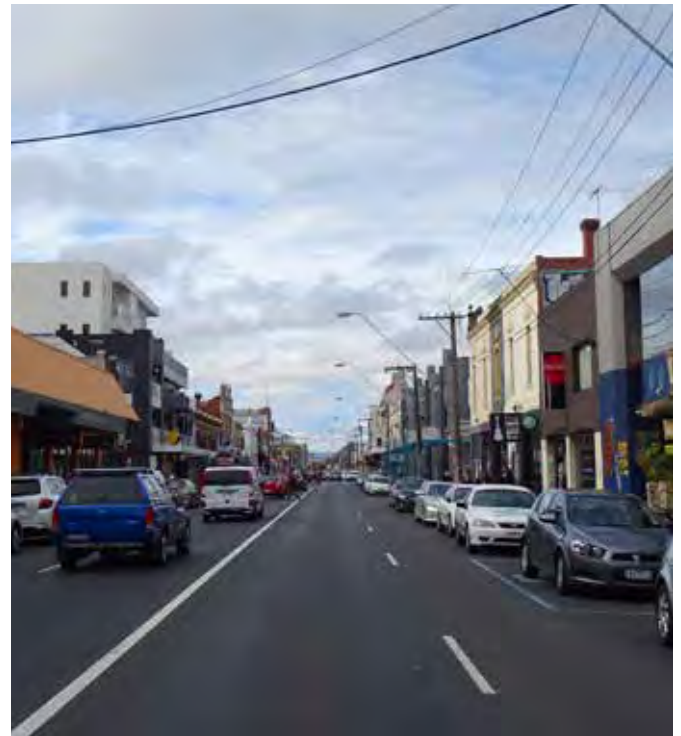
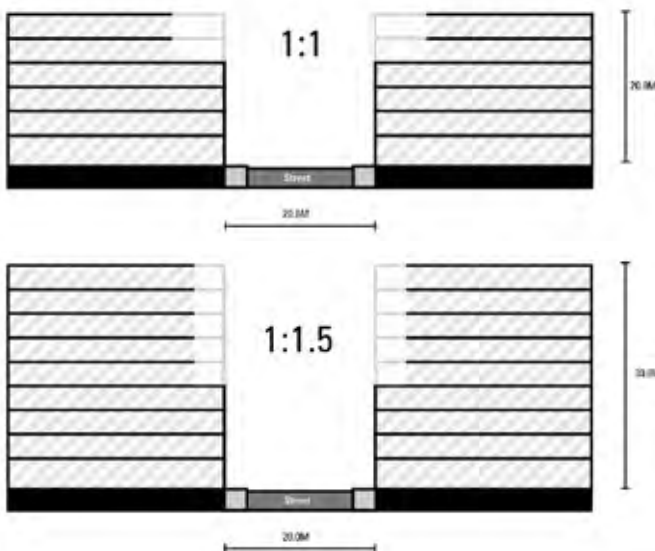

20m wide Johnston Street, looking east



10m wide Argyle Street, looking east

Solar Access

In inner urban areas such as Johnston St, access to sunlight is an important element. Therefore, the need to provide sufficient solar access to the public realm is vital to the ‘life’ and attraction of the street for people and businesses.

The *Urban Design Guidelines for Victoria* contains the following relevant Objective and associated guideline.

‘Objective 5.1.3 To ensure buildings in activity centres provide equitable access to daylight and sunlight’, and

‘5.1.3a Locate and arrange the building to allow daylight and winter sun access to key public spaces and key established street spaces.’

In Johnston St we recommend applying the equinox solar access test to streets to avoid overshadowing:

- the southern Johnston Street footpath between the 10am and 2pm;
- the western footpath from 10am onwards; and
- the eastern footpath before 2pm.

In order to provide appropriate levels of amenity to the various street conditions it was determined to maintain solar access to key pedestrian areas, being the southern footpath along Johnston Street and Victoria Street. While on narrower side streets it was determined to protect solar access to first floors.

There are no existing public open spaces within the Johnston St precinct which require protection from overshadowing and this highlights the importance of the public realm as public space. However, it was determined to protect the abutting Primary School grounds. Therefore, we recommend that development should not cause additional overshadowing of the following open spaces between 10am and 2pm at the equinox:

- Fitzroy Primary School (outdoor play area).

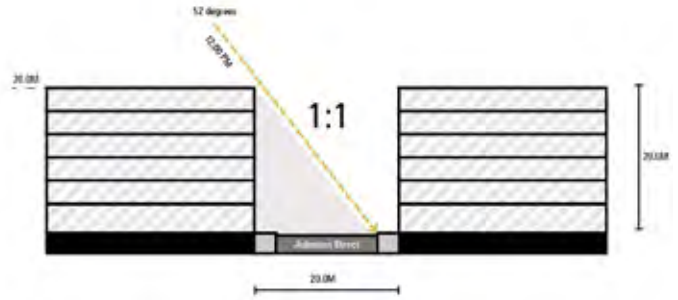

12pm equinox solar angle along Johnston Street

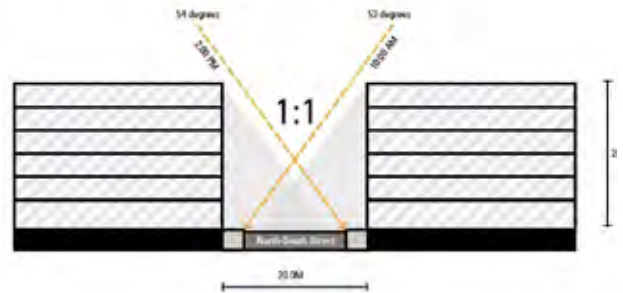

10am and 2pm equinox solar angles along north-south 20m wide street

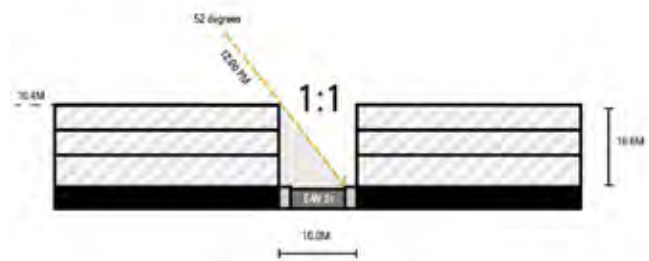

12pm equinox solar angle along east-west 10m wide street

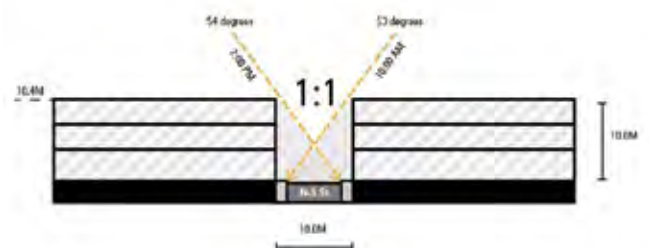

10am and 2pm equinox solar angles along north-south 10m wide street

Transitions

Transitions in scale are an existing characteristic of the Johnston St spine. There are examples of older 2 storey shop forms side by side with either single storey cottages or more recent 3 storey streetwall forms. A change in streetwall height of one storeys is therefore present along the Johnston Street corridor. However, given the street's main road function and linear nature, a future more consistent streetwall character is preferred.

In order to enhance the prevailing streetwall profile, particularly within the section of Johnston Street, to the west of Brunswick Street and along Victoria Street, new buildings must contain a streetwall that matches the height of any abutting heritage streetwall/building in order to maintain the prevailing streetscape character and streetwall modulation. Within the section of Johnston Street, to the east of Brunswick Street new buildings must contain a streetwall that either matches the height of any abutting heritage streetwall/building or is no greater than one storey higher in order to maintain the prevailing streetscape character and streetwall modulation.

Larger sites may be able to accommodate for gradual transitions through recessive upper levels and transition in scale in response to abutting heritage forms. In order to avoid undesirable 'wedding cake' forms, minimal 'steps' in built form massing is encouraged. Transitions in scale should as a minimum occur in paired levels or storeys.

On sites which directly abut single storey heritage forms and existing private open spaces a more tempered built form transition is recommended to ensure new form sensitively responds to the existing abuttal.



Varied streetwall presentation along southern side of Johnston Street

Slope

The Johnston St precinct is relatively flat, therefore the need for new built form to respond to slope is minimal.

Regardless, buildings should respond to the local topography. New buildings and streetwall presentations, particularly on sites with broad street frontages must 'step' ground floors to respond to the street level.

Buildings and sites which 'span' an entire urban block and contain frontages to more than one street should be designed to ensure that any change in topography between the different streets is responded to within the design and floor levels to ensure new buildings address street frontages at natural ground level.

Local Views and Vistas

There are no local views or vistas identified within this precinct that warrant specific protection. However, the presence of corner buildings is a key characteristic of Fitzroy, therefore retaining views to and 'space' behind these prominent corner forms is important to ensure they retain their prominence and 'hold' the corner. The following corner heritage buildings have been identified within the Johnston St precinct:

- The Tankerville Hotel;
- The Town Hall Hotel; and
- The Rochester Castle Hotel.



The Town Hall Hotel on corner of Johnston Street and Napier Street

Heritage Streetwall & Upper Levels

The extent of visible upper levels to heritage sites was determined by GJM Heritage and seeks to reinforce the provisions of Clauses 22.02 and 22.10. It was advised to apply a 'default' 1/3 - 2/3 visibility (sightline) test for heritage places from the opposite side of the street at standing eye level, with the appropriate visual presence of new built form deemed to 1/3 of the built form mass.

A 'default' minimum setback distance of 6m (to the new built form and balcony line) is suggested from the heritage facade. This allows for the preservation of the heritage 'volume' and ensures a viable facade articulation treatments in the streetscape elevation with spatial separation between the streetwall frontage and recessive upper levels (behind).

From a heritage perspective it is preferable to retain the 'heritage fabric' of the heritage form and not just the façade. This includes retaining visible chimneys and roof forms, while ensuring that any new upper levels are visually subservient to the heritage fabric.

The minimum 6m dimension accords with the 1/3 - 2/3 visibility test and generally allows for the retention of the entire 'front room' of the forms (assuming it is either a traditional shopfront form or a dwelling), including its roof form and chimneys.

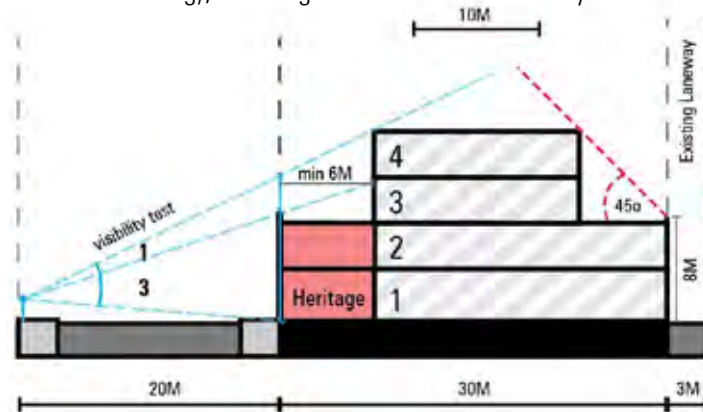

Cross-section of visibility test to upper level form behind heritage frontage

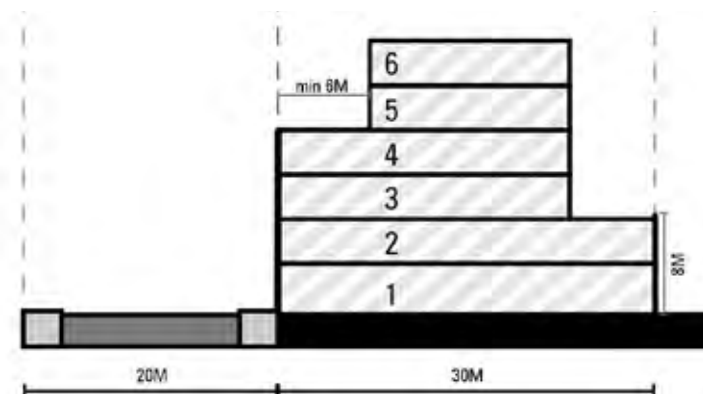

Cross-section of recessive upper level form behind new frontage

New Streetwall & Upper Levels

The visual distinction between streetwalls and upper levels is also important in relation to new streetwalls.

A 6m setback to upper levels above a new streetwall is also encouraged to all 20m wide streets to:

- provide a clear separation between the streetwall and upper forms;
- ensure new upper form do not visually dominate the streetscapes;
- create consistent upper level setbacks along streetscapes that comprise a mix of heritage and non-heritage forms; and
- reinforce the visual dominance of streetwalls.

The visual distinction between streetwalls and upper levels is less important in the narrow side street, within the commercial spine. This is because traditionally these side street locations often contain the sheer side presentation of buildings that front the main street spine and therefore comprise a more robust streetscape character.

A 3m setback to upper levels above new streetwall is encouraged to the narrower 10m wide side streets.

Upper Level Setbacks

In urban areas, almost all urban design guidelines seek to introduce a 'streetwall' and 'upper level front setback' measures.

The purpose for such a distinction and separation is to ensure predominance of the 'traditional' forms and parapets within the streetscape, while enabling provision of new and increased heights in a recessive fashion. Upper level setbacks also retain a sense of openness to the street, which are prominent in a pedestrian's field of vision and reinforce the traditional street wall scale.

In Johnston St there is extensive heritage fabric which is to be retained and enhanced. The recommended built form parameters for heritage sites draw on the provisions of Clauses 22.02 and 22.10 (refer Heritage Streetwall), as well as recommendations from other PSAs, their associated Panel reports and recent heritage advice from GJM Heritage.

The recommendations for non-heritage sites seeks to provide a clear distinction between streetwall presentations and upper forms, to reinforce the visual dominance of streetwalls (refer New Streetwall).

Upper Level Expression

The design of upper levels of new development should:

- be well articulated and break up the building mass;
- distinguish between the lower and upper levels through materials and articulation;
- be designed so that side walls are articulated and read as part of the overall building design and not detract from the streetscape when viewed from direct and oblique views along the streetscape; and
- provide passive surveillance of adjacent streets and public open space.

Main Street Corners

The streetwall presentation along ‘main streets’ (Johnston Street) needs to appropriately, ‘turn the corner’ into the ‘side street’ and transition to a different and often lower streetwall profile. New development should return the main street streetwall around the street corner and into the local street for a length of approximately 8m or to the nearest property boundary (if less than 8m).

Street Corners

Similar to main street corners, streetwall presentation along local streets also needs to ‘turn the corner’ and transition appropriately. Given Fitzroy’s local street network comprises both 20m and 10m wide streets it is often the case that streetwalls in wider streets are higher and streetwalls in narrower streets are lower. A sensitive streetwall transition is sought at these corner locations. New development should return the wider street’s streetwall around the street corner and into the narrower street for a length of approximately 8m or to the nearest property boundary (if less than 8m).

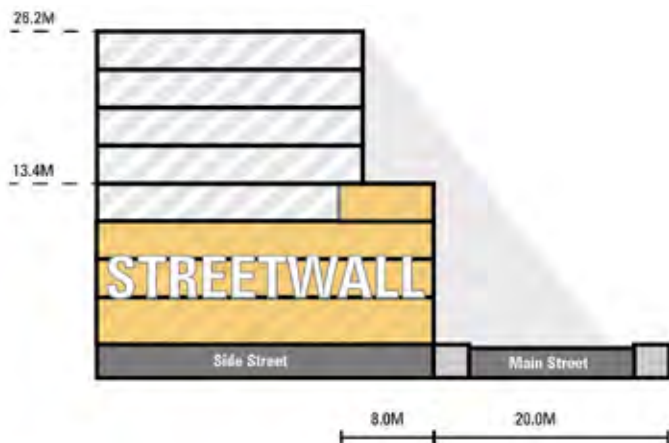

Elevation of side street frontage showing streetwall transition to corner

Building Separation, Amenity & Equitable Development

New development should provide a design response that considers the existing condition and future development opportunities of adjacent properties in terms of outlook, daylight and solar access to windows.

Development should be setback from common boundaries to provide separation between buildings at the upper levels:

- a minimum of 4.5m from the boundary where a habitable room window is proposed;
- a minimum of 3m from the boundary where a non-habitable room window or commercial window is proposed; and
- a minimum for 4.5m from the edge of a proposed balcony or terrace.

Where the common side boundary is a laneway, the setback is measured from the centre of the laneway.

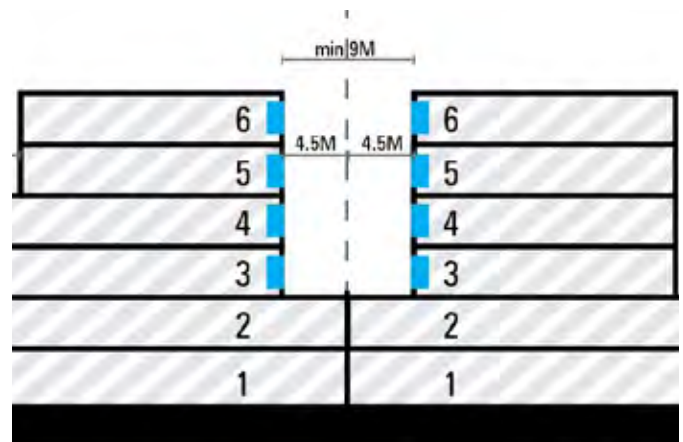

Cross-section of minimum 4.5m setback from habitable room window from common boundary at upper levels



Cross-section of minimum 4.5m setback from habitable room window from centre of a laneway at upper levels

Service Laneway Interfaces

Built form needs to respond to laneway interfaces. Within the Johnston St Precinct the existing laneways, their function, widths and arrangements vary considerably. New development will need to appropriately address both the existing laneway condition as well as adjacent properties. Generally, the most sensitive laneway interfaces occurs on the south side of east-west laneways, given potential amenity impacts of properties to the south. In particular, the east-west laneway which runs between Johnston Street and Victoria Street properties is important, due primarily to its length.

Sunlight to any existing habitable room windows and balconies (on the south side) should be maintained.

Therefore, we recommend:

- To laneway abutments new development should present a maximum 10.4m (3 storey) form at the interface, with any built form above set back 4.5m from the centreline of the laneway; and
- To the east-west laneway (behind 252-264 Johnston Street) new development should present a maximum 10.4m (3 storeys) from the interface, with any built form set back within a 45 degree built form envelope. In order to respect the abutting dwellings within the NRZ.



Cross-section of east-west laneway response to existing habitable room windows and balconies

Residential Interfaces

New development that is adjacent to a low-scale residential interface should:

- provide a transition in scale towards the property boundary with low-scale residential properties;
- seek to minimise presentation of visual bulk; and
- seek to minimise overshadowing impacts to secluded private open spaces.

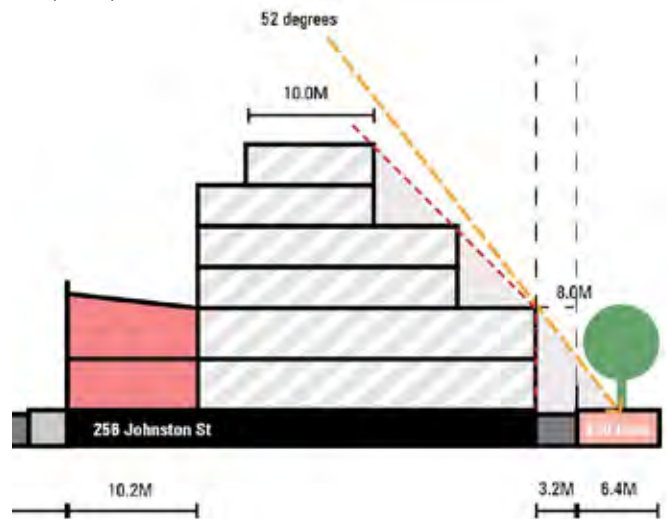

Cross-section of built form transition to NRZ land to south

Public Open Space Interface

New development should provide a suitable scale and transition at the interface with areas of open space ensuring that buildings do not visually dominate the public open space, whilst providing a sense of passive surveillance and visual interaction at lower levels. However, this precinct does not contain or abut any such public open space.



hansen
 Brunswick &
 Smith Street
 Built Form Review
 Johnston Street &
 Fitzroy East
 Built Form Control
 Figure 6



Legend

Precinct boundary
 Heritage sites
 Recommended Heritage sites
 Prominent corner building

Preferred Building Heights
 3 storeys / 10.4m
 4 storeys / 13.6m
 5 storeys / 16.8m
 6 storeys / 20m
 7 storeys / 23.2m
 8 storeys / 26.4m
 9 storeys / 29.6m

Preferred Streetwall
 Retain 1 storey heritage streetwall
 Retain 2+ storey heritage streetwall
 Retain small landscape setback
 New 2 storey streetwall (8m)
 New 3 storey streetwall (11m)
 New 4 storey streetwall (14m)

Interfaces
 Respond to direct residential abuttal
 Respond to southern interface
 Respond to 3 storey direct interface
 Respond to existing laneway interface
 Respond to new pedestrian laneway

Public Realm
 Potential future pedestrian link

Part 4 :

RECOMMENDED CONTROLS

4.1 Methodology

The formulation of future building heights and streetwall conditions within the Johnston St Precinct has been influenced by many factors, including:

- Planning Policy Framework;
- Local Planning Policy Framework, including Zones and Overlays;
- Practice Note No. 60 – Height and Setback Controls for Activity Centre;
- Practice Note No. 59 – The Role of Mandatory Provisions in Planning Schemes;
- Urban Design Guidelines for Victoria, 2017;
- Anticipated scale and form of development outside the study area (i.e. within Residential and Employment Zones);
- Views to existing landmarks from the public realm;
- Recognition of Yarra’s heritage skyline;
- Recent development approvals (including those currently under-construction);
- 3D computer modelling of built form testing for the study area;
- Independent heritage advice and existing character considerations, consistent with the expert heritage advice provided by Council’s heritage advisors (GJM Heritage);
- Extensive site inspections and workshops with Council’s officers;
- The overall Background report (dated X); and
- Consideration of the Johnston Street (C220) Panel report.

Assumptions

Formula for Deriving Numerical Building Heights

The maximum building heights has been calculated to a higher than minimum floor to floor heights in order to:

- Respond to the typical heights found within heritage buildings (between 8-11m);
- Accommodate for greater than minimum standards and provide flexibility for future uses; and
- Allowance for other design elements to be accommodated, such as parapets, railings, etc.

The following numerical floor to floor dimensions where employed:

- Ground Floor: 4m
- First Floor and above: 3.2m

Note: Higher numerical floor levels for mixed use development may be required at upper levels.

Formula for Deriving Numerical Streetwall Heights

The maximum streetwall heights have been calculated based on the above floor to floor heights, plus additional height to allow for parapets, balustrades and minor architectural features.

Zero front setback

New buildings within Activity Centres and inner urban areas such as Johnston St should generally be built to the street frontage in order to:

- Respond to the prevailing built form character of the area;
- Provide a clear definition at the street edge; and
- Maximise the developable area.

With the exception of retaining small front setbacks to heritage dwellings all new building within the commercial and mixed use zone should have a zero street setback.

Top Floor Depth

A minimum depth of approximately 10m has been used for the upper most level. This minimum dimension is based on a typical apartment depth, and provision of efficient access.

Upper Level Depth

A minimum depth of approximately 18m has been used for the upper levels. This minimum dimension is based on a typical apartment building arrangement, with a central corridor and apartments to either side.

4.2 Precincts

The preceding 'proposition' indicated that the Johnston St Precinct comprises two distinct precincts (sub-precincts).

These two precincts are distinctly different and primarily are defined by their heritage stock, land uses and subdivision pattern and are as follows:

- **Johnston St 1 (J1)** between Nicholson and Brunswick Streets; and
- **Johnston St 2 (J2)** between Brunswick and Smith Streets.

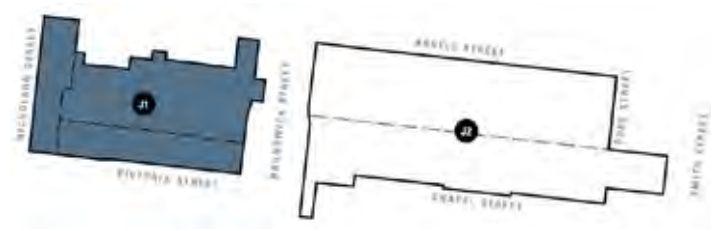

Johnston St 1 (J1)

Johnston St 1 is defined by more intact and consistent built form section of Johnston Street, to the west of Brunswick Street.

Built Form Objectives

- To sensitively 'mark' the western end of Johnston Street and lead into the main street character.
- To enhance the prevailing heritage 2 storey streetwall character along Johnston Street and contribute positively to the urban and traditional heritage shopfront character of a Fitzroy main street.
- To encourage sensitive infill and recessive upper level additions behind retained heritage facades and forms.
- To retain, enhance and incorporate the existing heritage streetwalls into future redevelopment to retain the prevailing streetscape character and built form rhythm.
- To protect solar access to southern footpath of Johnston



Non-heritage 2 storey streetscape on south side of Johnston Street



Heritage and non-heritage streetscape on the north side of Johnston Street



Non-heritage office building 'ripe' for redevelopment

Johnston St 2 (J2)

Johnston St 2 is defined by more diverse built form section of Johnston Street, between Brunswick Street and Smith Street.

Built Form Objectives

- To encourage sensitive infill and recessive upper level additions behind either retained heritage facades and new streetwalls along the southern side of Johnston Street.
- To foster an emerging, contemporary, commercial and mixed use character along the northern side of Johnston Street.
- To promote and encourage pedestrian activity through street activation, additional through block connections and protection of solar access to southern footpath of Johnston Street.
- To transition development down in scale to the northern Argyle Street edge.
- To ensure equitable development outcomes through building separation and gradual transitions to neighbouring heritage properties.

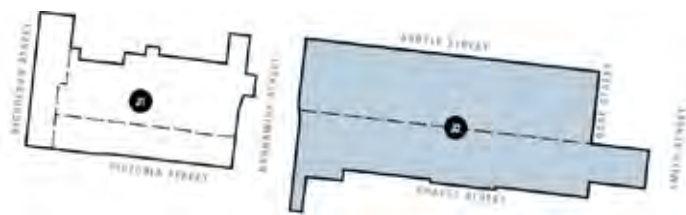

Non-heritage building on south side of Johnston Street, near Hertford Street



Prominent, former doctor's surgery on south side of Johnston Street



Non-heritage buildings on north side of Johnston Street, near Young Street

4.3 Sub-precincts

Given the significant variation and diversity (both lot attributes and existing built form) within each of these sub-precincts, is recommended to further divide them into urban blocks, to reinforce their built form distinction moving forward.

This is illustrated in Figure 7 which breaks Johnston St down to 5 block precincts, as follows:

Johnston St 1 (J1), 3 urban block precincts as follows:

- Nicholson Street (N1);
- Johnston Street west (JW1); and

- Victoria Street (V1).

Johnston St 2 (J2) 2 urban block precincts as follows:

- Johnston Street south (JS1); and
- Johnston Street north (JN1).

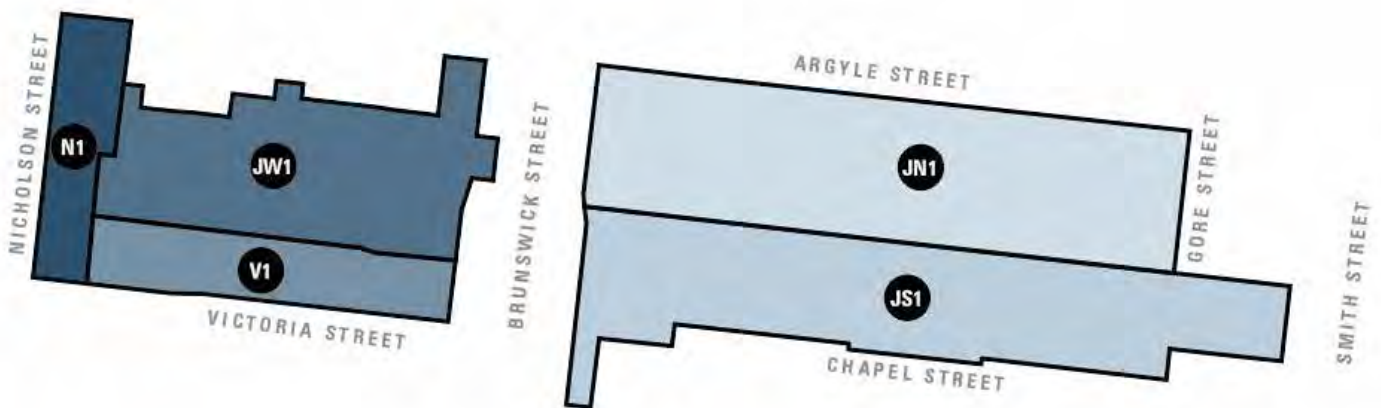

Proposed Building Heights

PRECINCT	SUB-PRECINCT	PREFERRED TYPOLOGY	PREFERRED MAXIMUM BUILDING HEIGHTS
JOHNSTON ST 1 (J1)	N1	Heritage retention & Redevelopment	6-9 storeys (20-29.6m)
	JW1	Heritage Shopfronts	6-8 storeys (20-26.4m)
	V1	Heritage Warehouse	6-8 storeys (20-26.4m)
JOHNSTON ST 2 (J2)	JS1	Heritage Shopfronts & Heritage house	4-6 storeys (13.6-20m)
	JN1	Redevelopment	6-8 storeys (20-26.4m)

JOHNSTON ST 1 (J1)

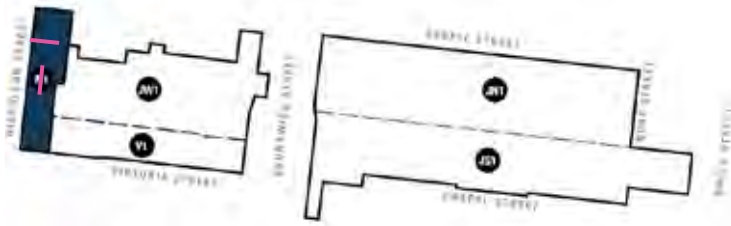

Nicholson Street (N1)

Description

The small subprecinct comprising properties which have a frontage to Nicholson Street, between Argyle Street and Victoria Street. These few properties 'define' the western end of the Johnston Street corridor. Across Nicholson Street the road profile changes to become Eglin Street characterised by a central median and street tree provision. The heritage forms of the Tankerville Hotel and former Avon Butter Factory create a low-rise corner presentation to the southern side of Johnston Street, as does the 'open' service station apron on the northern side. It is anticipated that the properties north of Johnston Street have development potential and are therefore likely to change.

Design Guidelines

- To define the western threshold to the Johnston Street corridor;
- To respond to the public transport provision along Nicholson Street;
- To maintain solar access to the southern footpath along Johnston Street at the equinox;
- To retain and enhance the low-rise heritage fabric;
- To encourage development on the northern side of Johnston Street; and
- To provide a transition between future forms fronting Nicholson Street and low-rise properties on the east of Harrison Place.

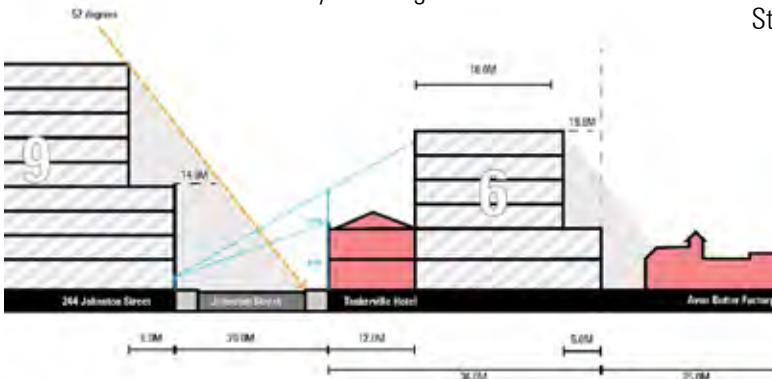

Johnston Street Indicative Cross-section (A-A)

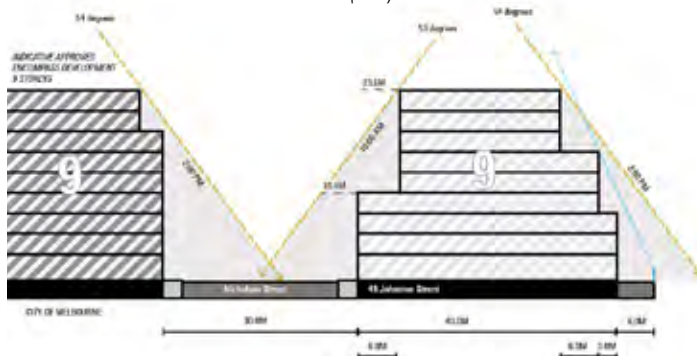

Johnston Street Indicative Cross-section (B-B)

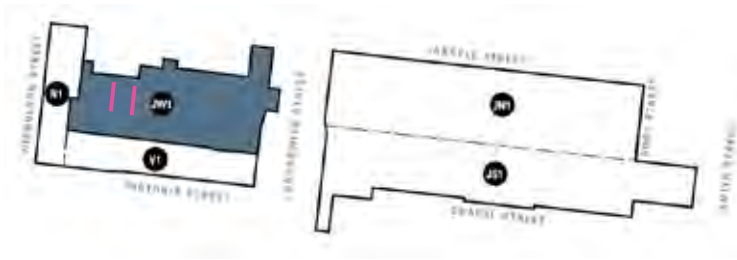

Johnston Street west (JW1)

Description

The subprecinct comprising properties which front either side of Johnston Street, between Harrison Place and the rear of properties fronting the western side of Brunswick Street. This section of Johnston Street presents a relatively consistent built form profile, with strong streetwall definition comprising predominately traditional shop fronts forms.

The southern side presents a more consistent streetwall character and finer grain forms, although there are a few larger and non-heritage sites that are 'ripe' for redevelopment.

The northern side presents a more varied built form character, comprising a mix of heritage dwellings and shop fronts, the prominent gym building and a few recent mid-rise developments.

This section of Johnston Street will continue to present a strong and consistent streetwall, with upper levels setback in order to maintain the visual primacy of the heritage fabric. However, along the southern side, a streetwall profile of contemporary 3 storeys matching abutting heritage facades is recommended, while along the northern side a taller 4 storey streetwall profile is recommended in order to reflect the existing profile of more prominent forms.

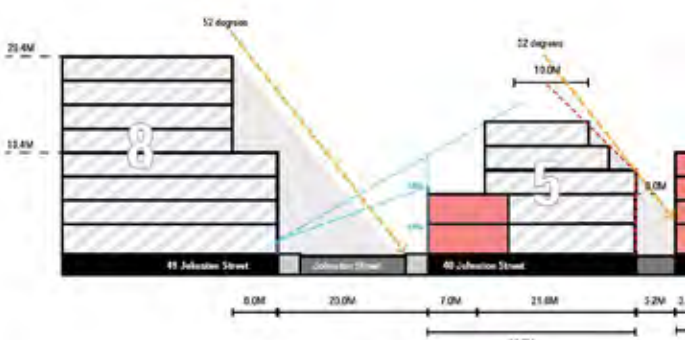

Johnston Street Indicative Cross-section (C-C)

Design Guidelines

- To maintain the existing streetwall character along Johnston Street;
- To maintain a sense of openness within the streetscape;
- To retain and enhance the fine grain heritage shop front fabric;
- To encourage development on the northern side of Johnston Street;
- To ensure a clear distinction between streetwall profile and rising form behind;
- To maintain solar access to the southern footpath along Johnston Street at the equinox; and
- To maintain solar access to existing dwellings to the south, (within V1).

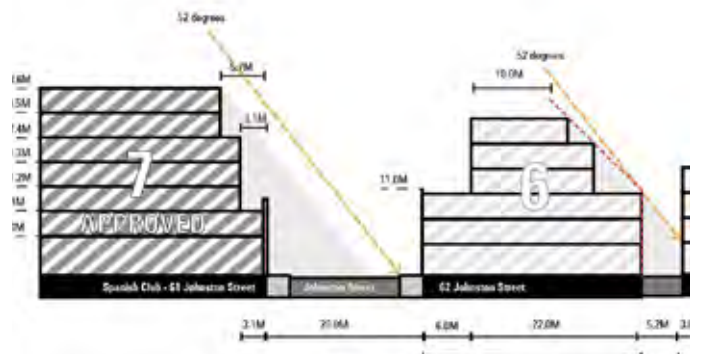

Johnston Street Indicative Cross-section (D-D)

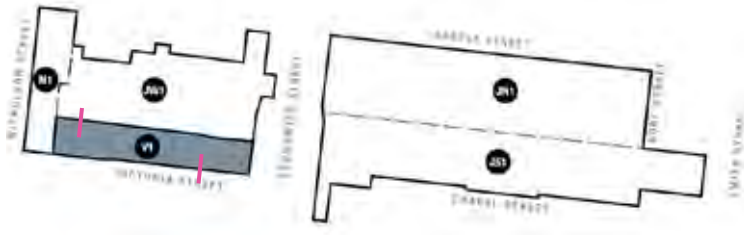

Victoria Street (V1)

Description

The subprecinct comprising properties which front the northern side of Victoria Street, between Nicholson Street and Smith Street. It comprises predominantly larger, former factory buildings of varied streetwall heights. The width and profile of Victoria Street also changes from east to west, whereby it comprises a 20m width towards the east and increases to 24m towards the west. Along the southern side of the street (outside the precinct) are residential properties.

Victoria Street will retain its 'robust' former industrial forms, with any additional upper level forms, being set back to present as light-weight and recessive additions. For non-heritage sites, new streetwalls profiles to 'match' neighbouring heritage streetwalls, with upper levels setback to maintain the visual primacy of the existing streetwall.

Design Guidelines

- To retain and enhance the former industrial heritage fabric;
- To encourage modest additions above and behind the heritage fabric;
- To maintain solar access to the southern footpath along Victoria Street at the equinox; and
- To ensure infill development sensitively fits into the surrounding heritage context.

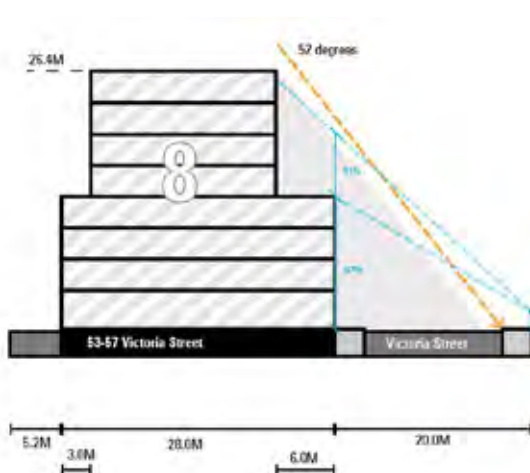

Victoria Street Indicative Cross-section (F-F)

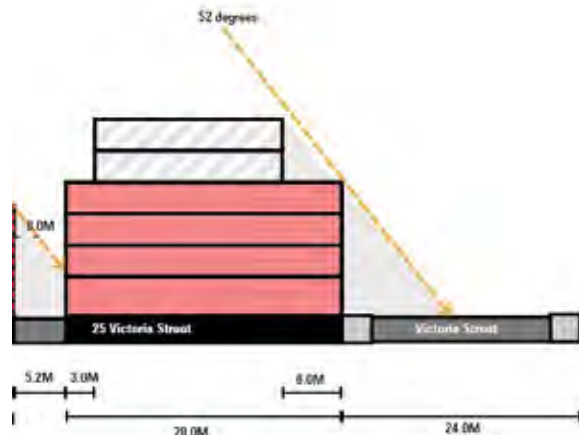

Victoria Street Indicative Cross-section (C-C)

JOHNSTON ST 2 (J2)

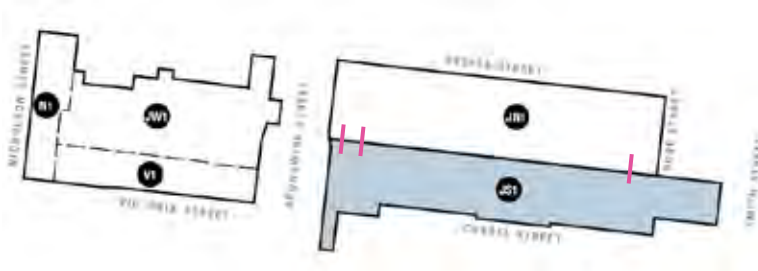

Johnston Street south (JS1)

Description

This subprecinct comprises all properties on the south side of Johnston Street, between Brunswick Street and Smith Street. It is the most diverse part of the Johnston Street corridor and comprises a varied built form character ranging from single storey heritage row houses to recent 6 storey mixed use developments. It also comprises two corner heritage pub buildings as well as traditional shop fronts, warehouse forms and heritage terraces in the local side streets.

The southern side of Johnston Street will continue to present a low-rise streetwall consisting of either retained heritage forms or new 3 storey streetwalls. Upper levels are to be modest and set back behind the defined streetwall in order to maintain the visual primacy of the streetwall.

The intact heritage dwellings, positioned in local streets and contiguous with neighbouring residential properties are recommended to be rezoned from Commercial 1 Zone to Neighbourhood Residential Zone. Such a rezoning would resolved their current anomaly and ensure appropriate built form control.

Design Guidelines

- To respond to the mixed built form character;
- To retain and enhance the low-rise and fine grain heritage fabric;
- To maintain and enhance sections of consistent streetwall character along Johnston Street;
- To maintain a sense of openness within the streetscape;
- To ensure a clear distinction between streetwall profile and rising form behind;
- To maintain solar access to existing dwellings to the south; and
- To maintain solar access to the Primary School grounds.

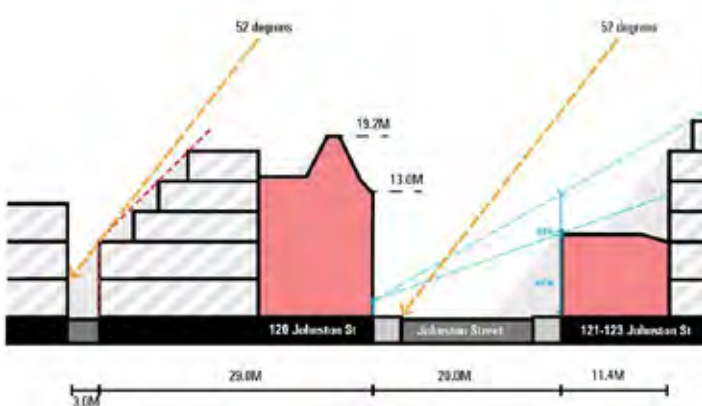

Johnston Street Indicative Cross-section (G-G)

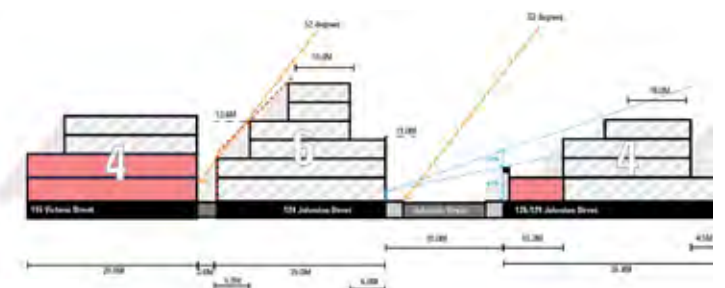

Johnston Street Indicative Cross-section (H-H)

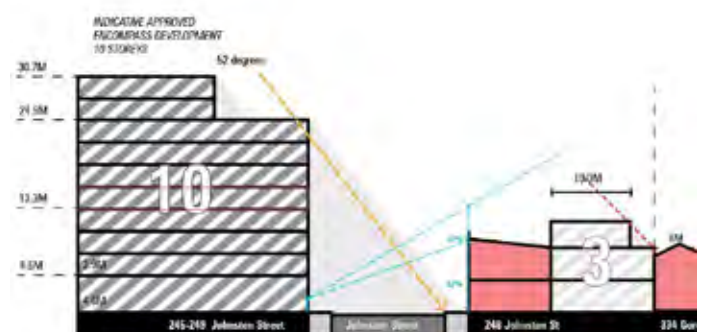

Johnston Street Indicative Cross-section (J-J)

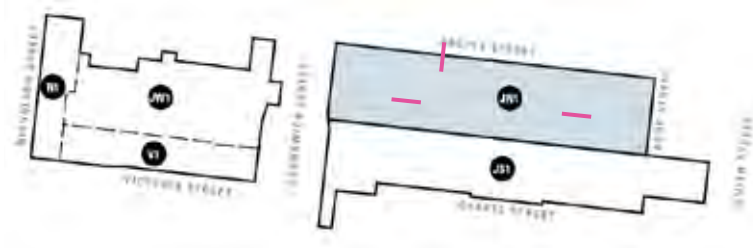

Johnston Street north (JN1)

Description

This subprecinct comprises all properties on the north side of Johnston Street, between Brunswick Street and Smith Street. It presents the most potential to accommodate built form change and comprises generally larger lot sizes, minimum heritage fabric and already contains a number of recent developments ranging between 6-10 storeys.

A new streetscape character along the northern side of Johnston Street is encouraged to create a more consistent 4 storey streetwall profile, with upper levels setback to ensure a clear distinction between streetwall and rising forms. Overall height up to 9 storeys is recommended for new forms, provided solar access is maintained along the southern footpath of Johnston Street.

To Argyle Street, a 3 storey streetwall presentation is recommended to respond to the narrower profile of the street, respect heritage dwellings (on the northern side of the street) and create a built form transition between the 9 storey forms (along Johnston Street) and more modest forms to the north, within the mixed use land.

Design Guidelines

- To encourage a new built form character on the northern side of Johnston Street;
- To encourage creation of new mid-block pedestrian connections;
- To maintain a sense of openness within the streetscape;
- To ensure a clear distinction between streetwall profile and rising form behind;
- To maintain solar access to the southern footpath along Johnston Street at the equinox; and
- To provide a transition between future forms fronting Johnston Street and Argyle Street.

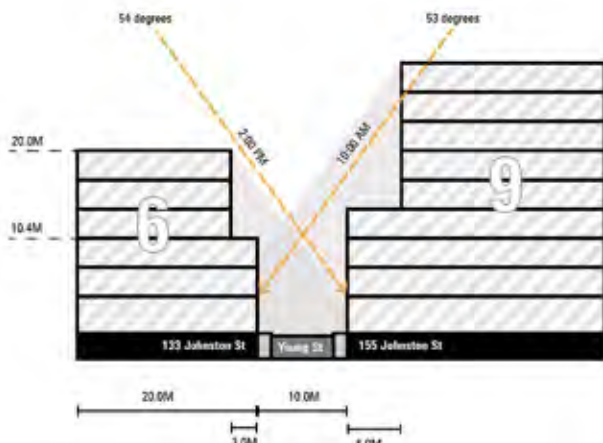

Young Street Indicative Cross-section (L-L)

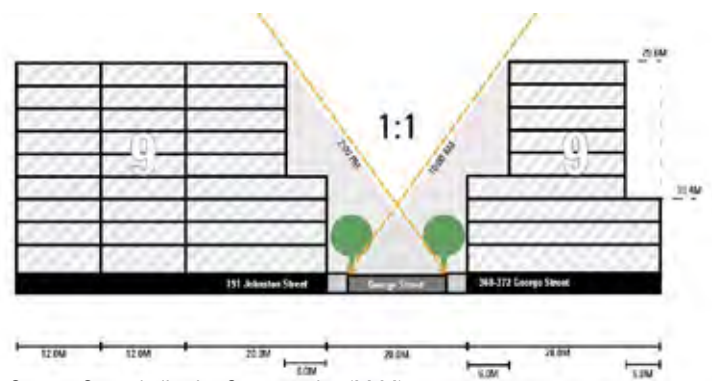

George Street Indicative Cross-section (M-M)

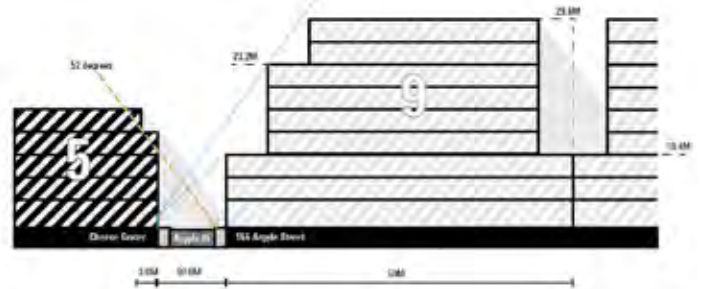

Argyle Street Indicative Cross-section (N-N)



hansen

Brunswick & Smith Street Built Form Review

Johnston Street Subprecinct Boundaries

Figure 7

Legend

- Johnston Street Precinct boundary
- Subprecinct boundaries
- Subprecinct



4.4 General Built Form Guidelines

Built Form Recommendations

A range of specific built form recommendations and design guidelines have been developed for all precincts.

These built form guidelines focus on the Johnston St Precinct, where future development is anticipated and design guidance is required.

Public Open Space provision

Public open space is an important element within urban areas, as is its spatial provision. In inner urban areas such as Johnston St the provision of small public parks is important to the social health and well-being of a local community. There are presently no 'pocket parks' within the Johnston St Precinct. Therefore, there is a clear lack of open space provision within this precinct. Given, the predicted population increase within this precinct, it is recommended that Council investigate opportunities to provide new public open spaces and/or increased public realm amenity.

Visually distinct additions and upper levels

Given the prevailing heritage character of Johnston St, new buildings or additions should be designed to have a visually distinctive architectural expression from the heritage element. This is in order to ensure that new form can be clearly 'read' and understood as a more recent component. It also encourages contemporary architectural responses which will contribute to the 'richness' and diversity of built form.

Lightweight materials, colours and finishes that contrast with the prevailing masonry forms are also encouraged to assist in the clear distinction between new and old, while also assist in visually recessing new forms.

Architectural Considerations

To street frontages expansive blank walls should be avoided and where visible from within the public realm any blank walls need to be visually divided into small elements through architectural treatments or artistic to reduce visual mass.

Fenestration patterns and facade solid to void proportions need to reflect the prevailing streetscape rhythm and presentation.

New forms should 'fit' within the prevailing streetscape character. Avoid overly busy and complex architectural expressions.

Active and Semi Frontages

In Activity Centres and Mixed Use areas, buildings must provide sufficient activation at street level to foster 'life' on the street and provide opportunities to maximise safety via passive surveillance.

Given Johnston Street's main street spine characteristics and its key movement corridor function, active ground frontages are encouraged. Active frontages along the street need to incorporate doors, and transparent windows at ground level which enable visual interaction and engagement between the inside of buildings and the street.

Direct pedestrian entry into ground floor uses is encouraged, particular on larger sites, with broad frontages.

Upper levels also provide 'eyes on the street' and contribute to passive surveillance of the public realm. Windows and balconies that orientate towards the street are encouraged.



Visually distinct upper levels along northern side of Johnston Street, near Fitzroy Street